

PERMANENT ELECTRICAL SAFETY DEVICES (PESDs®)

Enhance your electrical safety program through safety-by-design



NEW

ChekVolt®

Voltage Test Station



Voltage Indicator







Safe-Test Point™

GRACE PESDs® FEATURES

- ▶ **Permanent Electrical Safety Devices (PESDs®)** answer the most important question while performing Lockout/Tagout (LOTO); is there voltage? These externally mounted devices include voltage presence LED indicators, voltmeter compatible absence of voltage test points, and combination configurations.
- ▶ **PESDs®** are certified to UL 61010 and enhance safety by supporting the steps outlined in NFPA 70E 120.5: "Process for Establishing and Verifying an Electrically Safe Work Condition" and have proven to reduce LOTO procedure times by 35-40 minutes.
- ▶ Voltage Presence: **Voltage indicator PESDs®** illuminate when hazardous voltage is present until stored electrical energy is released, providing a warning of potential harm when maintenance personnel believe equipment to be in a de-energized state.
- ▶ Voltage Absence: When performing an absence of voltage test per NFPA 70E 120.5(7), **Safe-Test Point™** and **ChekVolt®** PESDs® feature high impedance protected test points that allow a qualified electrician to safely test phase-to-phase and phase-to-ground using an adequately rated portable test instrument.

GRACE PERMANENT ELECTRICAL SAFETY DEVICES (PESDs®)

PESDs® are rated up to 1000V, certified to UL 61010, and consist of externally installed voltage indicators, voltage portals, voltmeter test points, and combination units. PESDs provide visual indication or detection for voltage presence for mechanical Lockout/Tagout (LOTO).

⚡ Voltage Absence Testing	⚙️ Voltage Presence Testing	💡 Voltage Presence Indication & Absence Testing
  <p>Safe-Test Point™</p>	  <p>Voltage Indicators</p> <p>Voltage Portals</p>	  <p>Voltage Test Station</p> <p>ChekVolt®</p>

💡 GracePESDs® for Voltage Presence Indication & Absence Testing

The ChekVolt® and Voltage Test Station are two innovative products that offer enhanced safety, compliance, and productivity in mechanical and electrical LOTO procedures. The ChekVolt® features a compact design that provides voltage indication and voltmeter test points, while the Voltage Test Station combines a voltage indicator and Safe-Test Point™ in a single protective housing with an environmentally rated design.



NEW ChekVolt® allows you to test absence of voltage and provides voltage presence indication; all without opening the enclosure door. This touch-safe, compact PESD® features voltmeter compatible test points and redundant LED voltage presence indication. The ChekVolt® is quickly installed through a single 30mm knockout and includes four 14 AWG lead wires potted in the construction.



Voltage Test Station combines a R-3W Series voltage presence indicator with a Safe-Test Point™ within a protective, environmentally rated housing. Kits are also available of the Voltage Test Station and are available to meet application requirements including installation on equipment rated to 600 VAC and 1000 VDC. The Knockout kit allows the Voltage Test Station to be easily installed through two 30mm knockouts or the EZ-Upgrade kit makes it possible to upgrade to a Voltage Test Station on top of an existing Safe-Test Point™ or R-3W series voltage indicator.



ChekVolt®, Safe-Test Point™, and Voltage Test Station PESDs reduce electrical LOTO procedure times by 35-40 minutes and pay for themselves after 2-3 LOTO procedures from time savings alone.

GracePESDs® for Voltage Absence Testing

PESDs® are designed to comply with the NFPA 70E 120.5(7) standards, which require UL 61010 testing to verify absence of voltage with high impedance protected test points. Additional methods for absence of voltage testing have been introduced, but they do not replace nor negate previous methods using UL 61010 devices. Compliance using test point PESDs® remains valid and no exception is required.



Safe-Test Point™ provides an externally mounted source for qualified electricians to safely perform an absence of voltage test during electrical LOTO. The high impedance protected test points are compatible with portable test instruments (i.e. voltmeters). Safe-Test Points™ have several different models to fit the precise needs of the application. The standard Safe-Test Point™ is designed for 4-wire systems; however, the 5-wire version is designed for use on wye power systems with a neutral terminal.

GracePESDs® for Voltage Presence Indication

PESDs® that provide voltage indication and/or detection greatly assist task qualified personnel with enhanced productivity and reduced risk while performing mechanical LOTO tasks. Voltage indicators and portals provide indication when hazardous voltage is present until stored electrical energy is released, warning of potential harm when maintenance personnel believe equipment to be in a de-energized state. PESDs® can be hardwired to the line or load side of an electrical feeder or a disconnect switch to indicate when hazardous voltage is present in any individual phase.



Voltage indicator PESDs® are self-powered and visually represent the presence of hazardous voltage with flashing or non-flashing, redundant LED lights to assist with visual troubleshooting. Various indicators are available to meet a wide variety of applications including Variable Frequency Drives (VFDs), disconnect switches, and any enclosures where LOTO may be performed up to 1000 VAC/VDC. In addition, when connected to the load side the voltage indicator LEDs will indicate when stored energy has been fully dissipated.



Voltage portal PESDs® allow task qualified maintenance personnel equipped with an adequately rated CAT III/CAT IV Non-Contact Voltage Detector (NCVD) pen to perform voltage presence verification safely and productively from outside a grounded electrical enclosure. The voltage source can be detected by passing existing lead wires through the portal once it is installed through a 30mm standard punch hole.

GracePESDs® Combinations for Voltage Presence Indication & Absence Testing



Combination unit PESDs® include various configurations of any two types of the following PESDs®: R-3W Series voltage indicators, R-3K voltage portals, and R-3MT Safe-Test Points™. For example, two voltage indicators can be combined within a protective housing or with a custom label to indicate voltage presence for both the line and load side. These combination units are designed to meet the precise needs of any application. *Note: Voltage indicator and voltage portal combination units can only assist with mechanical LOTO.*





FOR MORE INFORMATION VISIT PESD.COM OR CALL 1.800.280.9517

© Grace Technologies All rights reserved. Specifications are subject to change with/without notice.

 **UL** **us** **RoHS** **CE**
LISTED

Individual product certifications may vary.
See Technical Specification charts.

CHEKVOLT® AND STANDARD VOLTAGE TEST STATION TECHNICAL SPECIFICATIONS

	CAT III 1000V, CAT IV 600V	CAT III & IV (Voltage Indicator & Test Points only)			
					
Product Number	R-3MT-VI-KIT	P-S10S21-M3RX P-S10S21-M3RX-V*	P-S11S21-M3RX P-S11S21-M3RX-V*	P-S12S21-M3RX P-S12S21-M3RX-V*	P-S21#2-M3RX P-S21#2-M3RX-V*
Description	NEW ChekVolt® Includes Cap Horizontal Label, and Flange Label	Voltage Test Station			
Voltage Indicator	All in One Unit Flashing LEDs	R-3W Flashing LEDs	R-3W2 Flashing LEDs, Class I Div 2	R-3W-SR Non-flashing LEDs	N/A
Safe-Test Point™	All in One Unit	R-3MT			
Voltage Type	AC/DC				
Mounting Location & Installation	External Mounting, One 30mm Knockout	External Mounting, M Housing Standard Mount: L: 6.50 (165.0) x W: 3.78 (96.0) x D: 2.50 (64.0)			
Operational & Storage Temperature Range	Operational: -20°C to +55°C Storage: -45°C to +85°C				
UL Rated AC Operational Range	Voltage Indicator: 20 - 1000 VAC Test Point: 0 - 1000 VAC 50/60/400Hz	Voltage Indicator: 40 - 600 VAC Test Point: 0 - 600 VAC 50/60/400Hz		Voltage Indicator: 35 - 600 VAC Test Point: 0 - 600 VAC 50/60/400Hz	Test Points: 0 - 600 VAC 50/60/400Hz
UL Rated DC Operational Range	Voltage Indicator: 20 - 1000 VDC Test Point: 0 - 1000 VDC	Voltage Indicator: 30 - 600 VDC Test Point: 0 - 600 VDC			Test Points: 0 - 600 VDC
Internal Resistance	164 kΩ in series on each input wire to respective output test jack (L1, L2, L3, GND)	102 kΩ in series on each input wire to respective output test jack (L1, L2, L3, GND)			
Correction Factor	Voltage Actual = 1.033 x Test Point voltage reading with a 10MΩ meter (measured voltage reads 3.3% less than actual due to internal impedance protection of the PESD)	Voltage Actual = 1.02 x Test Point voltage reading with a 10MΩ meter (measured voltage reads 2% less than actual due to internal impedance protection of the PESD)			
Wire/Wiring Specifications	PVC Insulated with Nylon Jacket, 8ft, 14 AWG, 90°C @ 1000V, UL-1452	PVC Insulated with Nylon Jacket, 8ft, 18 AWG, 90°C @ 1000V, UL-1452			
Environmental Ratings	UL Type 4, 4X, 12, 13 IP66, IP69	UL Type 4, 4X, 12 (dependent on housing specified) IP65			
UL File Number/CCN	E311256 / PICQ, PICQ7	E256847 / NKCR, NKCR7 (Voltage Indicator, Test Point) E311256 / PICQ, PICQ7 (Voltage Indicator, Test Point) E207344 / NITW, NITW2 (Housing)			
Certification Details	cULus Listed, CE, RoHS	UL Recognized, CE, RoHS			

*Part numbers ending in V are vertical mount units. **Warning:** Use of an Overcurrent Protection Device or Fuse is "NOT RECOMMENDED" when installing these devices in safety applications for verifying both voltage presence and voltage absence condition. A blown fuse or a tripped circuit breaker connected in line with this device could potentially lead to a false negative indication of voltage which is otherwise present. This device has been tested as equivalent to overcurrent protection for the application of tap conductor requirements.

FOR MORE INFORMATION VISIT PESD.COM OR CALL 1.800.280.9517

© Grace Technologies All rights reserved. Specifications are subject to change with/without notice.



Individual product certifications may vary.
See Technical Specification charts.

GracePESDs® Knockout & EZ-Upgrade Voltage Test Station Kits

The Knockout Voltage Test Station kit provides a versatile and accessible installation of the Safe-Test Point™ and voltage indicator through two 30mm knockouts, rather than using a traditional rectangular punch. The EZ-Upgrade kit is designed to help users upgrade from a standalone device, such as a Safe-Test Point™ or an R-3W series voltage indicator, into a complete Voltage Test Station assembly. This provides a more comprehensive and integrated solution, with improved safety and compliance features.

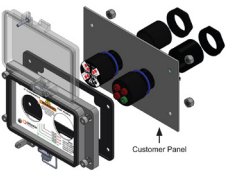

Knockout Voltage Test Station Kit
P-S10S21-M3RX**



EZ Upgrade Voltage Test Station Kit
R-3MT-EZ-H

Product Number	Knockout Voltage Test Station Description <i>(All unassembled kits. Installs with two 30mm knockouts and a housing that fits ovetop)</i>
H-S10S21-M3RX*	R-3W Voltage Indicator, Safe-Test Point™, Protective Housing and Magnetic Installation Template
H-S11S21-M3RX*	R-3W2 Voltage Indicator, Safe-Test Point™, Protective Housing and Magnetic Installation Template
H-S12S21-M3RX*	R-3W-SR Voltage Indicator, Safe-Test Point™, Protective Housing and Magnetic Installation Template
Product Number	EZ-Upgrade Voltage Test Station Description <i>(All unassembled kits. Upgrade existing products to Voltage Test station with one 30mm knockout)</i>
H-S10-M3RX-EZ*	R-3W Voltage Indicator, Protective Housing and Magnetic Installation Template
H-S11-M3RX-EZ*	R-3W2 Voltage Indicator, Protective Housing and Magnetic Installation Template
H-S12-M3RX-EZ*	R-3W-SR Voltage Indicator, Protective Housing and Magnetic Installation Template
H-S21-M3RX-EZ*	Safe-Test Point™, Protective Housing and Magnetic Installation Template
R-3MT-EZ-H**	Safe-Test Point™, Combo Label and Magnetic Installation Template
R-3W-EZ-H**	R-3W Voltage Indicator, Combo Label and Magnetic Installation Template

UL Type 4 shown, other UL type housings are available. Part numbers starting with H are units that come with a protective housing.

*For vertical units add -V to the above part numbers. **For vertical units replace -H with -F.

Contact your local Sales Representative for more information.

R-3MT-VI DETAIL *For more details on each product please refer to their respective installation guide(s).*

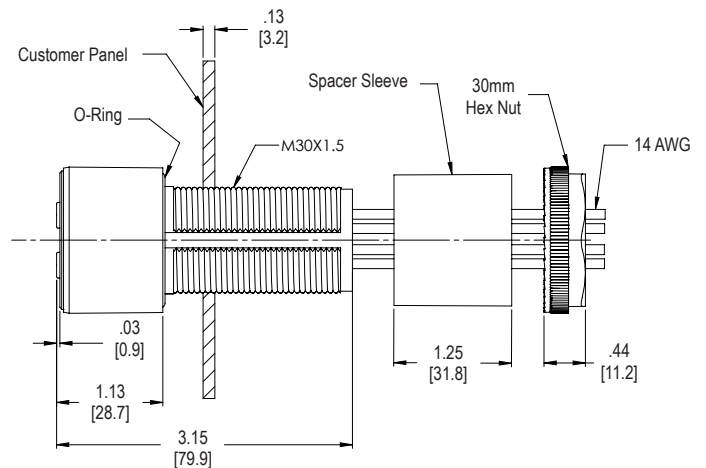
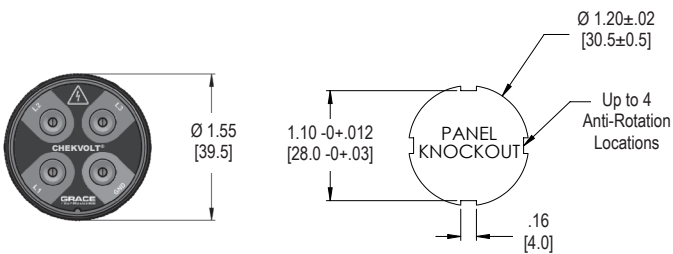

EQUIPMENT REQUIREMENTS

- Voltage test instrument with 1000V rated input minimum, a typical 10M Ω input impedance and CAT III 1000V and CAT IV 600V.
- A pair of insulated test probes with 0.080" DIA. points with minimum probe insertion length of 0.480".

ACCESSORIES



R-3MT-VI-LF

Warning Labels



ChekVolt® horizontal warning label.....R-3MT-VI-LH

ChekVolt® flange warning label.....R-3MT-VI-LF

Custom label variations available upon request.
Please call 1-800-280-9517 for more information.

FOR MORE INFORMATION VISIT PESD.COM OR CALL 1.800.280.9517

DC VOLTAGE TEST STATION TECHNICAL SPECIFICATIONS

			
Product Number	P-S14S26-M3RX* P-S14S23-M3RX*	P-S14S27-M3RX*	P-S14S23-M3RX*
Voltage Indicator	R-3W-DC Flashing LEDs		
Test Points	One Red +ve and One Yellow -ve Insulated Jack	One Red +ve Insulated Jack and One Black -ve Insulated Jack	One Red +ve and One White -ve Insulated Jack and 1 Green GND Insulated Jack
Voltage Type	DC		
Mounting Location & Installation	External, M Housing Standard Mount: L: 6.50 (165.0) x W: 3.78 (96.0) x D: 2.50 (64.0)		
Operational & Storage Temperature Range	Operational: -20°C to +55°C Storage: -45°C to +85°C		
UL Rated AC Operational Range	Voltage Indicator: 15 - 600 VAC Test Point: 0 - 600 VAC 50/60/400Hz		
UL Rated DC Operational Range	Voltage Indicator: 15 - 600 VDC Test Point: 0 - 600 VDC		
Internal Resistance	102 kΩ in series on each input wire to respective output test jack (+ve and -ve)	102 kΩ in series on each input wire to respective output test jack (+ve, -ve, and GND)	
Correction Factor	Voltage Actual = 1.02 x Test Point voltage reading with a 10MΩ meter <i>(measured voltage reads 2% less than actual due to internal impedance protection of the PESD)</i>		
Wire/Wiring Specifications	PVC Insulated with Nylon Jacket, 8ft, 18 AWG, 90°C @ 1000 Volts, UL-1452		
Environmental Ratings	UL Type 4, 4X, 12 (dependent on housing specified) IP65		
UL File Number/CCN	E256847 / NKCR, NKCR7 (Voltage Indicator, Test Point) E311256/PICQ, PICQ7 (Voltage Indicator, Test Point) E207344/NITW, NITW2 (Housing)	E256847 / NKCR, NKCR7 (Voltage Indicator, Test Point) E311256/PICQ, PICQ7 (Voltage Indicator, Test Point) E207344/NITW, NITW2 (Housing)	E256847 / NKCR, NKCR7 (Voltage Indicator, Test Point) E311256/PICQ, PICQ7 (Voltage Indicator, Test Point) E207344/NITW, NITW2 (Housing)
Certifications	UL Recognized, CE, RoHS		

*UL Recognized with maximum voltage is limited to 600V AC/DC. Product can be used up to 1000V DC without UL Recognition. **Warning:** Use of an Overcurrent Protection Device or Fuse is "NOT RECOMMENDED" when installing these devices in safety applications for verifying both voltage presence and voltage absence condition. A blown fuse or a tripped circuit breaker connected in line with this device could potentially lead to a false negative indication of voltage which is otherwise present. This device has been tested as equivalent to overcurrent protection for the application of tap conductor requirements.

M HOUSING DETAIL

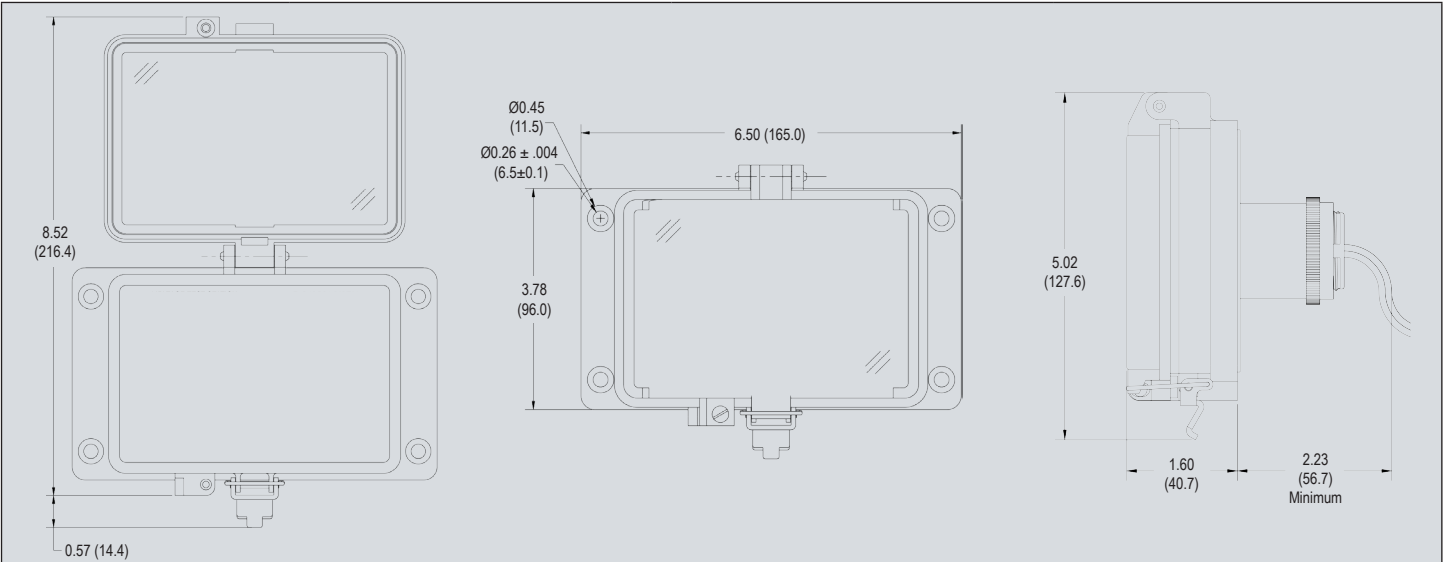

HOUSING CODE	M2	M3	M4
UL TYPE	4X	4	12
IP Rating	IP65		N/A
DIMENSIONS L x W x D IN/MM (OVERALL)	L: 6.50 (165.0) X W: 3.78 (96.0) X D: 2.50 (64.0)		

DC VOLTAGE INDICATOR AND TEST POINT DETAILS TYPICAL WIRING CONFIGURATION

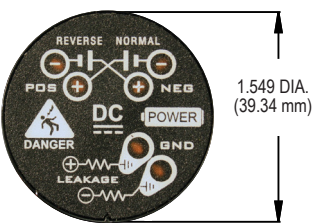

- One Red +ve Insulated Jack and One Black -ve Insulated Jack *(applies to P-S14S27-M3RX only)*
- One Red +ve Insulated Jack and One White -ve Insulated Jack and One Green GND Insulated Jack *(applies to P-S14S23-M3RX only)*
- 0.080" DIA Pin Sockets
- Minimum Insertion length: 0.480"

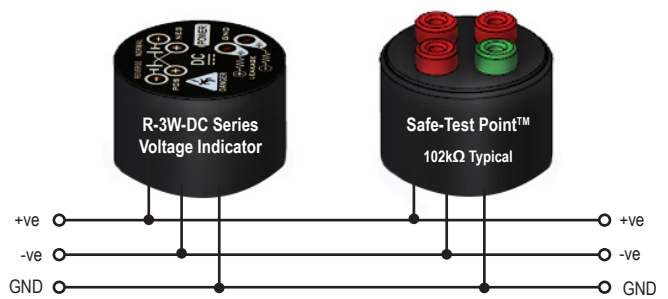

Note: Above wiring configuration applies to P-S14S23-M3RX only. Wiring configuration for P-S14S27-M3RX same as the above except GND does not exist. The DC Voltage Test Station can be installed on either the load or line side based on your application.

EQUIPMENT REQUIREMENTS

- Voltage test instrument with 1000VDC rated input minimum, a typical 10MΩ input impedance.
- A pair of insulated test probes with 0.080" DIA. points with minimum probe insertion length of 0.480".



FOR MORE INFORMATION VISIT PESD.COM OR CALL 1.800.280.9517

© Grace Technologies All rights reserved. Specifications are subject to change with/without notice.



Individual product certifications may vary. See Technical Specification charts.

SAFE-TEST POINT™ TECHNICAL SPECIFICATIONS

	CAT III 1000V, CAT IV 1000V	CAT III 1000V, CAT IV 600V	CAT III 600V, CAT IV 600V
	 R-3MT-1K-KIT-H	 R-3MT-KIT-H	 R-5MT
Product Number	R-3MT-1K-KIT-H* R-3MT-1K-KIT-F*	R-3MT-KIT-H* R-3MT-KIT-F*	R-5MT* R-5MT-4X* R-5MT-12*
Description	1K 4-Wire Safe-Test Point™ with Label and Dust Cap	4-Wire Safe-Test Point™ with Label and Dust Cap	5-Wire Safe-Test Point™
Safe-Test Point™	R-3MT-1K	R-3MT	Manual Interface w/Meter
Voltage Type	AC/DC		
Mounting Location & Installation	External Mounting, One 30mm Knockout		External Mounting, F Housing Standard Mount: L: 6.50 (165.0) x W: 3.78 (96.0) x D: 2.50 (64.0)
Operational & Storage Temperature Range	Operational: -20°C to +55°C Storage: -45°C to +85°C		
UL Rated AC Operational Range	0 to 1000 VAC phase to phase and/or phase to ground 50/60/400Hz	0 to 600 VAC phase to phase and/or phase to ground 50/60/400Hz	
UL Rated DC Operational Range	0 - 1000 VDC		0 - 600 VDC
Internal Resistance	164 kΩ in series on each input wire to respective output test jack (L1, L2, L3, GND)	102 kΩ in series on each input wire to respective output test jack (L1, L2, L3, GND)	102 kΩ in series on each input wire to respective output test jack (L1, L2, L3, N, GND)
Correction Factor	Voltage Actual = 1.033 x Test Point voltage reading with a 10MΩ meter (measured voltage reads 3.3% less than actual due to internal impedance protection of the PESD)	Voltage Actual = 1.02 x Test Point voltage reading with a 10MΩ meter (measured voltage reads 2% less than actual due to internal impedance protection of the PESD)	
Wire/Wiring Specifications	PVC Insulated with Nylon Jacket, 8ft, 14 AWG, 90°C @ 1000 Volts, UL-1452	PVC Insulated with Nylon Jacket, 8ft, 18 AWG, 90°C @ 1000 Volts, UL-1452	
Components	Three Red jacks (L1, L2, L3), 1 Green jack (GND), .080" DIA pin sockets, minimum probe insertion length .480"		Three Red jacks (L1, L2, L3), 1 Black jack (Neutral), One Green jack (GND), .080" DIA pin sockets, minimum probe insertion length .480"
Environmental Ratings	UL Type 4, 4X, 12, 13	UL Type 12, 13 IP67	UL Type 4, 4X, 12 (depending on housing specified) IP65 (only applies to 4, 4X housings)
File Number/CCN	E311256 / PICQ, PICQ7		E311256/PICQ, PICQ7 (Test Point) E207344/NITW, NITW2 (Housing)
Certifications	cULus Listed, CE, RoHS		UL Recognized, CE, RoHS

*Custom configurations including 2 - 4 test points are available. Contact your Grace Representative for more information. **Warning:** Use of an Overcurrent Protection Device or Fuse is "NOT RECOMMENDED" when installing these devices in safety applications for verifying both voltage presence and voltage absence condition. A blown fuse or a tripped circuit breaker connected in line with this device could potentially lead to a false negative indication of voltage which is otherwise present. This device has been tested as equivalent to overcurrent protection for the application of tap conductor requirements.

FOR MORE INFORMATION VISIT PESD.COM OR CALL 1.800.280.9517

© Grace Technologies All rights reserved. Specifications are subject to change with/without notice.

 **UL** **RoHS** **CE**

Individual product certifications may vary.
See Technical Specification charts.

DETAIL For more details on each product please refer to their respective installation guide(s).

R-3MT and R-3MT-1K

R-5MT

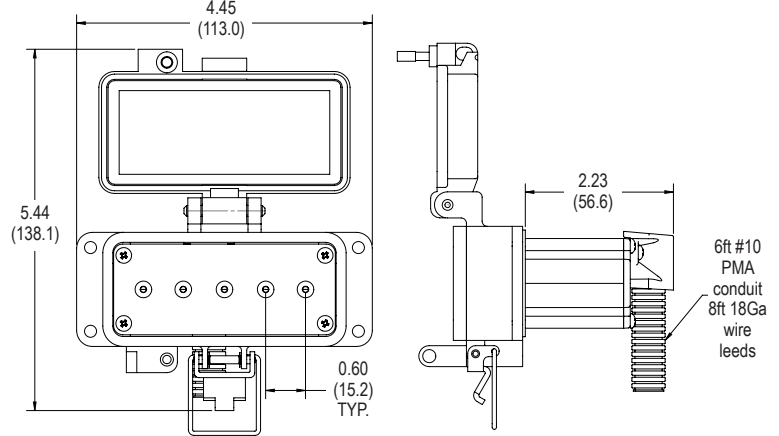
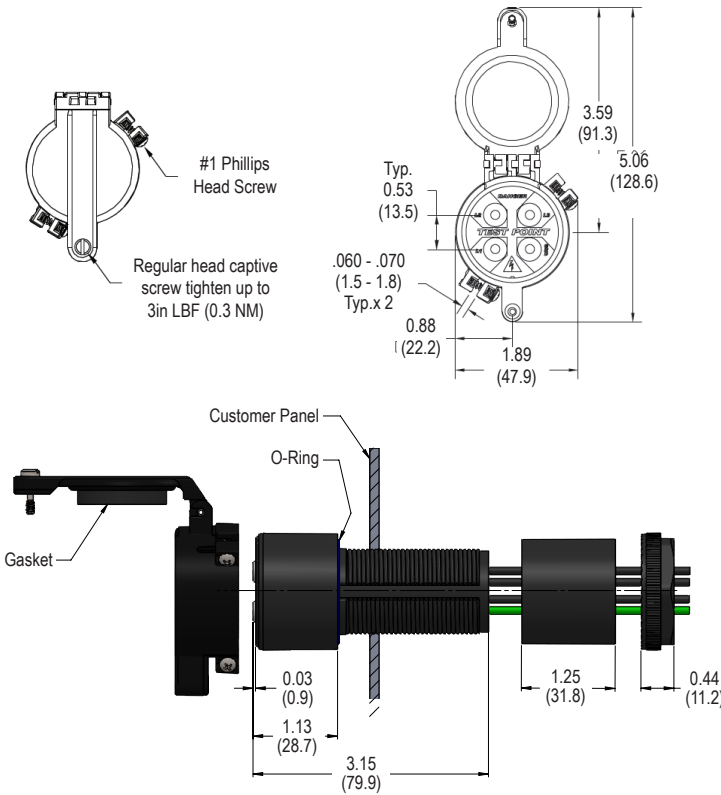

R-3MT-1K-KIT TERMINATIONS

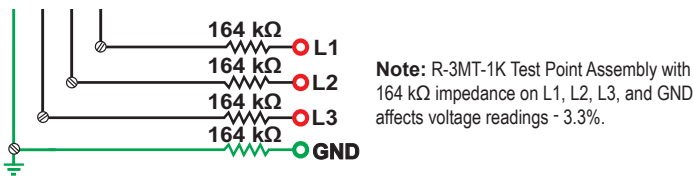

R-3MT & R-5MT TERMINATIONS

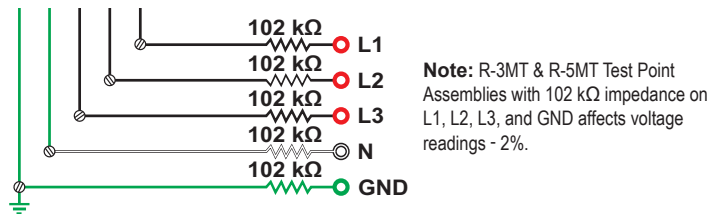

EQUIPMENT REQUIREMENTS

- Voltage test instrument with 1000V rated input minimum, a typical 10MΩ input impedance and CAT III 1000V and CAT IV 600V.
- A pair of insulated test probes with 0.080" DIA. points with minimum probe insertion length of 0.480".

ACCESSORIES

Warning Labels

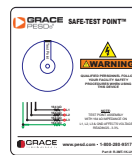







R-3MT-1K-LH

- R-3MT-1K Safe Test Point™ horizontal warning label.....R-3MT-1K-LH
- R-3MT-1K Safe Test Point™ and flange warning label.....R-3MT-1K-LF
- R-3MT Safe Test Point™ and horizontal warning label.....R-3MT-LH
- R-3MT Safe Test Point™ and flange warning label.....R-3MT-LF

Custom label variations available upon request. Please call 1-800-280-9517 for more information.

FOR MORE INFORMATION VISIT PESD.COM OR CALL 1.800.280.9517

VOLTAGE INDICATOR TECHNICAL SPECIFICATIONS

	CAT III 1000V, CAT IV 600V						Medium & High Voltage	
								
Product Number	R-3W R-3W-KB*	R-3W-SR R-3W-SR-KB*	R-3W2 R-3W2-KB* Class 1 Div 2	R-3F2 Available in: 12", 24", 36", 48", and 72"	R-3W-DC R-3W-DC-KB*	R-3D2 R-3D2-SR R-3D2-W5 R-3D2-SR5	R-1VL003	R-1VH003
Product Description	Voltage Indicator			Fiber Optic Voltage Indicator	DC Voltage Indicator	Flex-Mount Voltage Indicator	Medium Voltage Indicator	
Voltage Indicator	Flashing LEDs	Non-Flashing LEDs	Flashing LEDs			Flashing/ Non-Flashing LEDs	Flashing LEDs	
Voltage Type	AC/DC				DC	AC/DC	AC	
Mounting Location & Installation	External Mounting, One 30mm Knockout or One 43mm Through Hole Low Profile Bezel Mount*					External Mounting 3/4" conduit (1.15" actual) or M20 Knockout (0.79" actual)	Internal Mounting (BUS) 1/2" Bolt Ring Terminal	
Operational & Storage Temperature Range	Operational: -20°C to +55°C Storage: -45°C to + 85°C				Operational: -40°C to +55°C Storage: -45°C to +55°C	Operational: -20°C to +55°C Storage: -45°C to + 85°C	Operational: -20° - 80°C Storage: Not Available	
UL Rated AC Operational Range	40 - 600 VAC 50/60/400Hz	35 - 600 VAC 50/60/400Hz,	40 - 600 VAC 50/60/400Hz,	20 - 600 VAC 50/60/400Hz,	20 - 600 VAC 50/60/400Hz,	20 - 600 VAC 50/60/400Hz	2kV-15kV	15kV-43kV
UL Rated DC Operational Range	30 - 1000 VDC			20 - 1000 VDC	15 - 1000 VDC		N/A	N/A
Wire/Wiring Specifications	PVC Insulated with Nylon Jacket, 8ft, 18 AWG, 90°C @ 1000 Volts, UL-1452						N/A	
Lead Connections	3 Phase, 4-Wire				1 Phase, 3 -Wire	3 Phase, 4 and 5-wire	1/2" Ring Terminal	
Environmental Ratings	UL Type 4, 4X, 12, 13 IP67		UL Type 4X, 12, 13 IP67	UL Type 4X, 12, 13 IP66	UL Type 4, 4X, 12, 13 IP67	UL Type 4X, 12, 13 IP67	N/A	N/A
File Number/CCN	E256847 / NKCR, NKCR7 E311256 / PICQ, PICQ7		E334597 / NOIV, NIOV7	E334957 / NOVI, NOVI7 E311256 / PICQ, PICQ7	E256847 / NKCR, NKCR7 E311256 / PICQ, PICQ7	E256847 / NKCR, NKCR7 E334957 / NOVI, NOVI7 E311256 / PICQ, PICQ7	N/A	N/A
Certifications	cULus Listed, CE, RoHS		cULus Listed, CE, Class 1 Div 2 Group A, B, C & D, IP67	cULus Listed, CE, RoHS Class 1 Div 2 Group A, B, C & D	cULus Listed, CE, RoHS	cULus Listed, CE, RoHS, Class 1 Div 2 Group A, B, C & D	N/A	N/A

*Part numbers listed are Bezel Kits complete with both the Bezel and Voltage Indicator. **Warning:** Use of an Overcurrent Protection Device or Fuse is "NOT RECOMMENDED" when installing these devices in safety applications for verifying both voltage presence and voltage absence condition. A blown fuse or a tripped circuit breaker connected in line with this device could potentially lead to a false negative indication of voltage which is otherwise present. This device has been tested as equivalent to overcurrent protection for the application of tap conductor requirements.

FOR MORE INFORMATION VISIT PESD.COM OR CALL 1.800.280.9517

© Grace Technologies All rights reserved. Specifications are subject to change with/without notice.



Individual product certifications may vary.
See Technical Specification charts.

DETAIL

R-3W Series Voltage Indicator

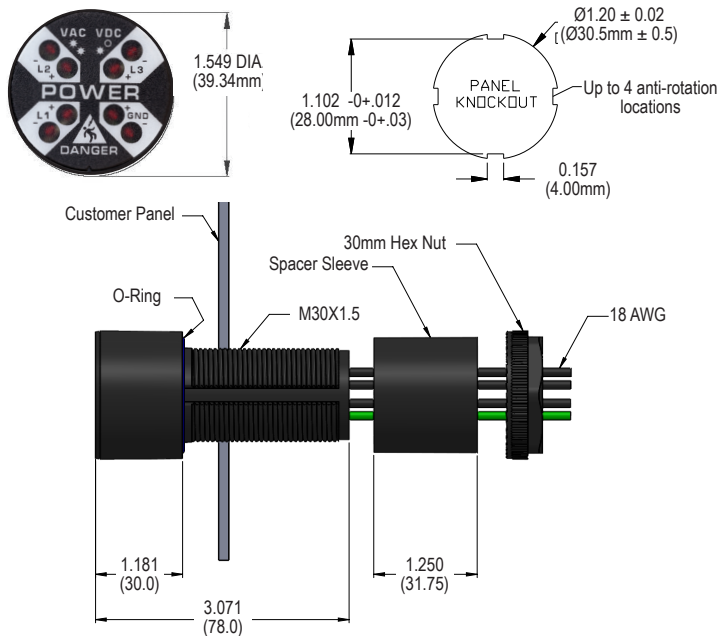

R-1V Medium Voltage Indicator

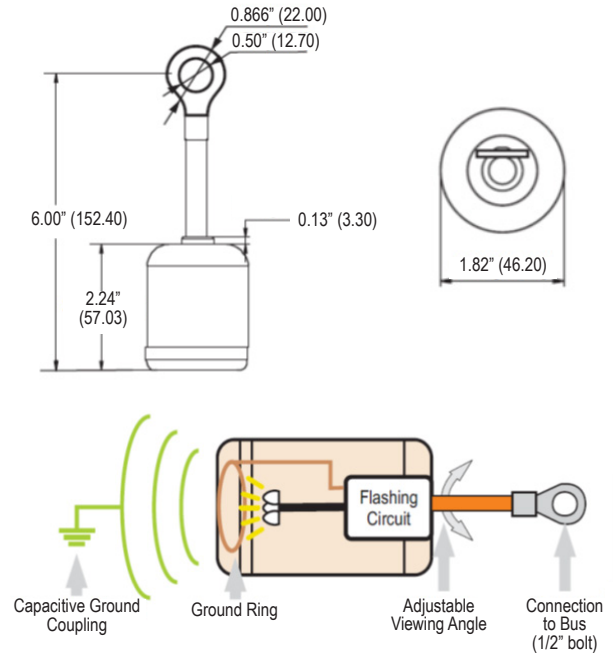

ACCESSORIES

Voltage Indicator Kits and Warning Labels

Install around the R-3W Series Voltage Indicators.



R-3W-L-KIT

R-3W Voltage indicator and warning label.....	R-3W-L-KIT
Warning label.....	R-3W-L
R-3W Voltage indicator, bezel mount and warning label.....	R-3W-KB-KIT
Warning label for bezel mount.....	R-3W-KB-L
Vertical warning label.....	R-3W-NP-F



Front View

Bezel Mount Kits

Creates a low-profile look. Bezel mount and Voltage indicator are sold together in the kits below.

R-3W Voltage indicator with bezel.....	R-3W-KB-L-KIT*
R-3W-SR Voltage indicator with bezel.....	R-3W-SR-KB*
R-3W2 Voltage indicator with bezel.....	R-3W2-KB*
R-3W-DC Voltage indicator with bezel.....	R-3W-DC-KB*



Back View

*These labels install around the R-3W Series Voltage Indicators. The labels are not UL approved.

Conduit Adapter

Applies to R-3W, R-3W2, R-3W-SR, R-3W-DC. Voltage Indicator sold separately.



30mm - 1 1/4" Conduit adapter (shown to the left).....	R-3W-NPT125
1 1/2" Conduit adapter with VI nameplate (vertical) (not shown).....	R-3W-NPT150-NP



Door Mount Kit

Applies to R-3W, R-3W2, R-3W-SR, R-3W-DC, and R-3MT-VI. Voltage Indicator and ChekVolt® sold separately.

Door mount kit with 6' cable.....	R-3W-DR-C6
-----------------------------------	------------

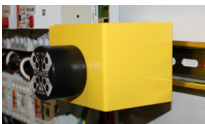

DIN Rail Bracket

See voltage sources inside your panel by allowing mounting directly to your DIN rail. Applies to R-3W, R-3W2, R-3W-SR, R-3W-DC. Voltage Indicator sold separately.

R-3W Voltage indicator with bezel.....	R-3W-DIN
--	----------



Viewing Window

Install on the outside of the cabinet to view the Medium Voltage Indicator.

UL Type 4X.....	P-W1-M2RX
UL Type 4.....	P-W1-M3RX
UL Type 12.....	P-W1-M4RX



FOR MORE INFORMATION VISIT PESD.COM OR CALL 1.800.280.9517

© Grace Technologies All rights reserved. Specifications are subject to change with/without notice.



Individual product certifications may vary. See Technical Specification charts.

R-3W SERIES VOLTAGE INDICATOR AND SAFE-TEST POINT™ COMBO TECHNICAL SPECIFICATIONS

	CAT III 1000V, CAT IV 600V			CAT III & CAT IV
	All R-3W combos supplied with R-3MT or R-3MT-1K, label and dust cap.	 R-3WMT-LMH	 R-3W2MT-LMF	 R-3WSMT-LMH
Product Number	R-3WMT-LMH* R-3WMT-LMF*	R-3W2MT-LMH* R-3W2MT-LMF*	R-3WSMT-LMH* R-3WSMT-LMF*	R-3WMT1K-LMH* R-3WMT1K-LMF*
Description	R-3W Series Voltage Indicator and Safe-Test Point™ Combination			
Voltage Indicator	R-3W Flashing LEDs	R-3W2 Flashing LEDs, Class I Div 2	R-3W-SR Non-flashing LEDs	R-3W Flashing LEDs
Safe-Test Point™	R-3MT			R-3MT-1K
Voltage Type	AC/DC			
Mounting Location & Installation	External Mounting, Two 30mm Knockouts			
Operational & Storage Temperature Range	Operational: -20°C to +55°C Storage: -45°C to +85°C			
UL Rated AC Operational Range	Voltage Indicator: 40 - 600 VAC Safe-Test Point™: 0 - 600 VAC 50/60/400Hz		Voltage Indicator: 35 - 600 VAC Safe-Test Point™: 0 - 600 VAC 50/60/400Hz	Voltage Indicator: 40 - 600 VAC Safe-Test Point™: 0 - 1000 VAC 50/60/400Hz
UL Rated DC Operational Range	Voltage Indicator: 30 - 1000 VDC Safe-Test Point™: 0 - 600 VDC			Voltage Indicator: 30 - 1000 VDC Safe-Test Point™: 0 - 1000 VDC
Internal Resistance	102 kΩ in series on each input wire to respective output test jack (L1, L2, L3, GND)			164 kΩ in series on each input wire to respective output test jack (L1, L2, L3, GND)
Correction Factor	Voltage Actual = 1.02 x Test Point voltage reading with a 10MΩ meter (measured voltage reads 2% less than actual due to internal impedance protection of the PESD)			Voltage Actual = 1.033 x Test Point voltage reading with a 10MΩ meter (measured voltage reads 3.3% less than actual due to internal impedance protection of the PESD)
Wire/Wiring Specifications	PVC Insulated with Nylon Jacket, 8ft, 18 AWG, 90°C @ 1000 Volts, UL-1452			Voltage Indicator: PVC Insulated with Nylon Jacket, 8ft, 18 AWG Wire, 90°C @ 1000V, UL-1452 Safe-Test Point™: PVC Insulated with Nylon Jacket, 8ft, 14 AWG Wire, 90°C @ 1000 Volts, UL-1452
Environmental Ratings	Voltage Indicators: UL Type 4, 4X, 12, 13 Safe-Test Point™: UL Type 12, 13			
File Number/CCN	E256847 / NKCR, NKCR7 (Voltage Indicator, Test Point)		E311256/PICQ, PICQ7 (Voltage Indicator, Test Point)	
Certifications	cULus Listed, CE, RoHS			cULus Listed, CE, RoHS CAT III 1000V, CAT IV 600V (Voltage Indicator) CAT III 1000V, CAT IV 1000V (Test Point)

*Part numbers ending in H are horizontal mount units and labels. Part numbers ending in F are flange mount units and labels. Dust cap and label are not UL or CE certified.
Warning: Use of an Overcurrent Protection Device or Fuse is "NOT RECOMMENDED" when installing these devices in safety applications for verifying both voltage presence and voltage absence condition. A blown fuse or a tripped circuit breaker connected in line with this device could potentially lead to a false negative indication of voltage which is otherwise present. This device has been tested as equivalent to overcurrent protection for the application of tap conductor requirements.

DETAIL For more details on each product please refer to their respective installation guide(s).

R-3MT and R-3MT-1K

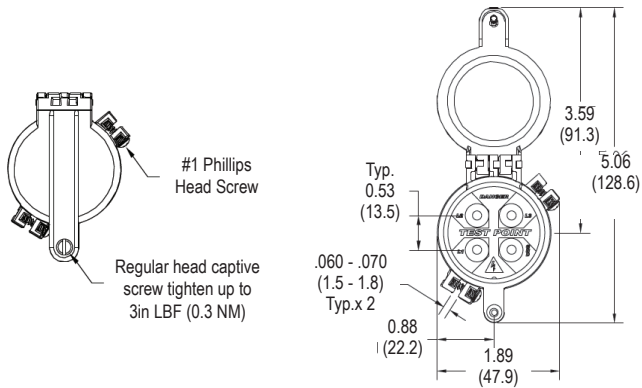

R-3W Series Voltage Indicator

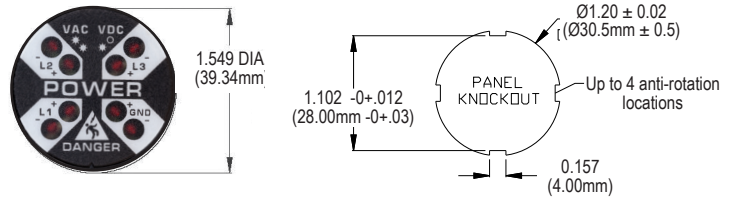

TYPICAL WIRING CONFIGURATION

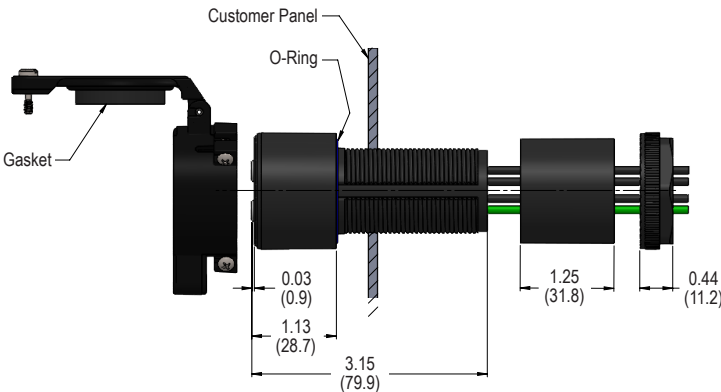
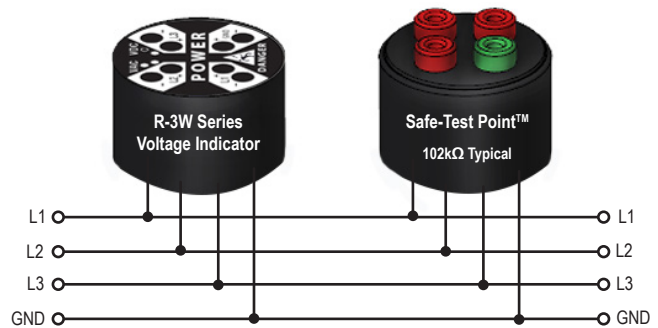

R-3MT TERMINATIONS

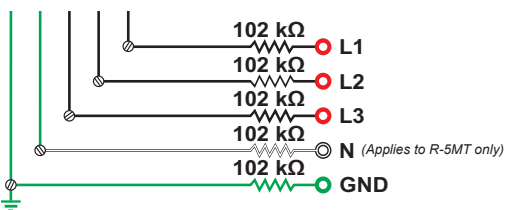

EQUIPMENT REQUIREMENTS

- Voltage test instrument with 1000V rated input minimum, a typical 10MΩ input impedance and CAT III 1000V and CAT IV 600V.
- A pair of insulated test probes with 0.080" DIA. points with minimum probe insertion length of 0.480".

ACCESSORIES

Warning Labels

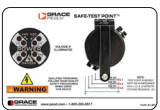

R-3WMT-LMH

R-3W Voltage indicator, R-3MT Safe-Test Point™, horizontal warning label.....R-LMH*

R-3W Voltage indicator, R-3MT Safe-Test Point™, flange warning label.....R-LMF*

Custom label variations available upon request. Please call 1-800-280-9517 for more information.







FOR MORE INFORMATION VISIT PESD.COM OR CALL 1.800.280.9517

© Grace Technologies All rights reserved. Specifications are subject to change with/without notice.



Individual product certifications may vary. See Technical Specification charts.

VOLTAGE PORTAL TECHNICAL SPECIFICATIONS

		CAT III 1000V, CAT IV 600V (Voltage Indicator only)			
		 R-3KW-LCH  R-3KW-LCF	 R-3KW2-LCH  R-3KW2-LCF	 R-3KWS-LCH  R-3KWS-LCF	
Product Number	R-3K R-3K-KIT*	R-3KW-LCH R-3KW-LCF	R-3KW2-LCH R-3KW2-LCF	R-3KWS-LCH R-3KWS-LCF	
Description	R-3K Pass-Through	R-3K Pass-Through and Voltage Indicator Combination			
Voltage Indicator	N/A	R-3W Flashing LEDs	R-3W2 Flashing LEDs, Class 1 Div 2	R-3W-SR Non-Flashing LEDs	
Voltage Type	AC				
Mounting Location & Installation	External Mounting One 30mm Knockout Standard Mount	External Mounting, One 30mm Knockout			
Operational & Storage Temperature Range	Operational: -20°C to +60°C Storage: Not Available				
UL Rated AC Operational Range	1000 VAC Maximum - Minimum voltage sensing value vary by the type and class of NCVD pen used	Voltage Indicator: 20 - 600 VAC 50/60/400Hz Voltage Portal: 1000 VAC Maximum - Minimum voltage sensing value vary by the type and class of NCVD pen used			
UL Rated DC Operational Range	N/A	30 - 1000 VDC			
Wire/Wiring Specifications	Accepts wires from 18AWG - 12AWG	PVC Insulated with Nylon Jacket, 8ft, 18 AWG, 90°C @ 1000 Volts, UL-1452			
Lead Connections	R-3K used in conjunction with up to 3 live leads	R-3K used in conjunction with PESD® leads			
Pollution Degree	2				
Chemical Resistance	Characteristics of polycarbonate material apply (see Voltage Portal Chemical Resistance Application Note for more details)				
Environmental Ratings	UL Type 4, 4X, 12	N/A			
File Number/CCN	E311256 / PICQ, PICQ7	E256847 / NKCR, NKCR7 (Voltage Indicator) E311256 / PICQ, PICQ7 (Voltage Indicator, Voltage Portal)	E334597 / NOIV, NIOV7 (Voltage Indicator) E311256 / PICQ, PICQ7 (Voltage Portal)	E256847 / NKCR, NKCR7 (Voltage Indicator) E311256 / PICQ, PICQ7 (Voltage Indicator, Voltage Portal)	
Certifications	cULus Listed, CE, RoHS				

*Heat shrink caps included with product (for use with customer supplied wires.) **Warning:** Use of an Overcurrent Protection Device or Fuse is "NOT RECOMMENDED" when installing these devices in safety applications for verifying both voltage presence and voltage absence condition. A blown fuse or a tripped circuit breaker connected in line with this device could potentially lead to a false negative indication of voltage which is otherwise present. This device has been tested as equivalent to overcurrent protection for the application of tap conductor requirements.

R-3K DETAIL

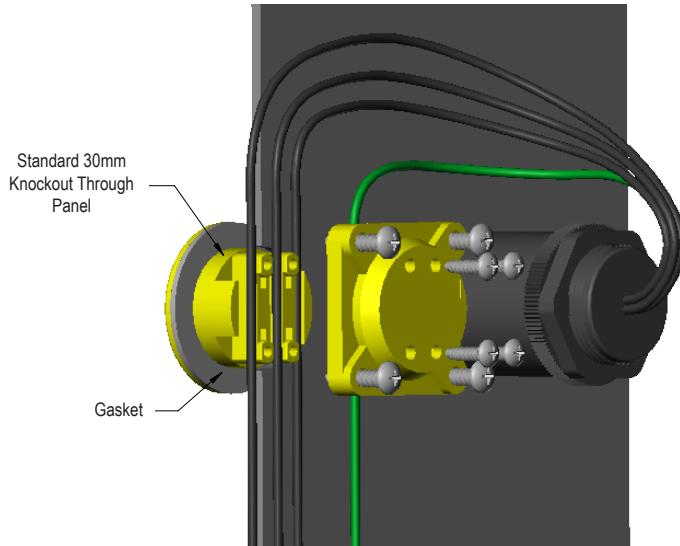

R-3K AND VOLTAGE INDICATOR DETAIL

3 Phase leads combined into one unit
(no need for additional wiring)

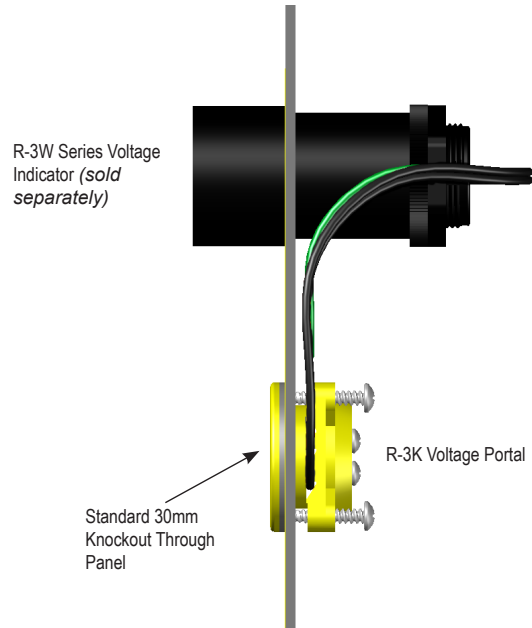

R-3K WIRING

Independently:

- The R-3K can be connected directly to the source using customer supplied wires ranging from 12-AWG to 18-AWG.
- Pass the desired lead wires (L1, N, GND for single phase; or L1, L2, L3 for three phase) through the voltage portal device and terminate the wire ends using heat shrink end caps (available upon request).

With a Voltage Indicator Combination:

- The R-3K can be installed using the wires from new or existing voltage indicators. (See detail above for use with an existing voltage indicator).
- With the indicator installed, simply pass the existing indicator leads through the portal.
- This combination provides a safety redundancy for voltage presence indication with flashing or non-flashing LED lights from the voltage indicator.

ACCESSORIES



R-3K-LH

Warning Labels

R-3K horizontal warning label.....	R-3K-LH
R-3K flange warning label.....	R-3K-LF
R-3K Voltage portal and voltage indicator horizontal warning label.....	R-3K-LCH
R-3K Voltage portal and voltage indicator, and flange warning label.....	R-3K-LCF

Custom label variations available upon request.
Please call 1-800-280-9517 for more information.

FOR MORE INFORMATION VISIT PESD.COM OR CALL 1.800.280.9517

© Grace Technologies All rights reserved. Specifications are subject to change with/without notice.



Individual product certifications may vary.
See Technical Specification charts.

FREQUENTLY ASKED QUESTIONS

Q: Where are PESDs® installed on equipment?

A: PESDs® can be directly wired to either the load side or line side of the LOTO voltage source point. They can also be directly wired onto the bus below the fuses to measure a blown fuse or a tripped circuit breaker.

Q: What would a typical LOTO procedure include with the Safe-Test Point™ or ChekVolt®?

A: Follow NFPA 70E Article 120.5: "Process for Establishing and Verifying an Electrically Safe Work Condition". The Safe-Test Point™ and ChekVolt® allow voltage measurements from line-to-line and line-to-ground to test for absence of voltage safely from outside the enclosure.

Q: Do I need Personal Protective Equipment (PPE) with PESDs®?

A: Use the recommended PPE based on your facility's electrical safety program and adhere to the PPE guidelines in Table 130.5(G) or Table 130.7(C)(15)(c) of NFPA 70E.

Q: Do PESDs® satisfy the NEC feeder tap rule?

A: Yes, PESDs® have a built-in high impedance between the feeder line connecting leads and the circuitry, hence it satisfies the NEC 10 ft. feeder tap rule without overcurrent protection.

Q: What is CAT III & CAT IV rating and why is it important for PESDs®?

A: CAT III & IV ratings define the overvoltage installation categories that applies to low voltage systems of <1000V measuring and test equipment as defined in IEC 1010 and UL61010-1 standards. The rating of our PESDs® allows their use as permanently mounted test equipment used for fixed installations (switchgear, MCCs, bus, and feeder) in industrial plants and low voltage connections made to utility power.

Q: How do I perform a "live-dead-live" test with the Safe-Test Point™ or ChekVolt®?

A: Always follow LOTO procedures as per Article 120.5 and "live-dead-live" test procedure as per Article 120.5(7) of NFPA 70E. Using a properly rated test instrument, verify the test instrument to a known source then insert the test probes into the test point assembly to verify the presence of voltage. Next, open the isolator and proceed to test for absence of voltage on the device assembly by measuring the voltage line-to-line and line-to-ground (L1-L2, L1-L3, L2-L3, L1-G, L2-G, L3-G). Once you have tested for absence of voltage, re-verify the test instrument to any known source.

Q: What are the recommended connection accessories for the Voltage Test Station?

A: Always ensure any accessory is compatible with your specific application and voltage. We suggest the following connectors (based on typical applications): T&B Sta-Kon Series, 3M Scotchlok, Wago 773 Series, or Wago 222 Series.

Q: Where should fiber optic voltage indicators (R-3F2) be used?

A: Fiber optic voltage indicators are ideal for use in the dead front electrical cabinets where voltage is more than 24V is not allowed at the door.

Q: Do the R-3W series voltage indicators have internal short circuit protection?

A: Yes, the voltage indicator is protected by high impedance circuitry and recognized components that limit the power to 1.2watts @ 750 Volts AC. The following chart gives the phase to ground short circuit currents.

Voltage Indicator included Fault Current (PHASE-TO-GROUND SHORT)

3- Phase Line-To-Line (VAC) 30 120 240 480 750

0 OHM Phase-To-Ground Current (µA) 28 108 219 455 730



For a complete listing of Frequently Asked Questions please scan the QR Code to the left to go to our Knowledge Base.

